

PR
electronics



5 3 3 1

**2-tråds programmerbar
transmitter**

Nr. 5331V113-DK

Fra serienr. 141365001



ATEX



Revision Notes

The following list provides notes concerning revisions of this document.

Rev. ID	Date	Notes
113	13/45	IECEX and INMETRO approvals added

2-TRÅDS PROGRAMMERBAR TRANSMITTER

PRetop 5331

Indholdsfortegnelse

Anvendelse.....	2
Teknisk karakteristik	2
Montage / installation.....	2
Applikationer	3
Bestillingsskema: 5331.....	4
Elektriske specifikationer	4
Tilslutninger.....	8
Blokdiagram	9
Programmering	10
Mekaniske specifikationer.....	11
Montering af følerledninger	11
Appendix	12
ATEX Installation Drawing - 5331A	13
ATEX Installation Drawing - 5331D	14
IECEX Installation Drawing - 5331A.....	16
IECEX Installation Drawing - 5331D.....	17
FM Installation Drawing - 5331D.....	19
CSA Installation Drawing - 5331D.....	21
INMETRO Instruções de Segurança - 5331A.....	22
INMETRO Instruções de Segurança - 5331D.....	23

2-TRÅDS PROGRAMMERBAR TRANSMITTER PRetop 5331

- *Indgang for RTD, TC, Ohm eller mV*
- *Ekstrem målenøjagtighed*
- *1,5 kVAC galvanisk isolation*
- *Programmerbar følerfejlsværdi*
- *Kan monteres i DIN form B følerhoved*

Anvendelse

- Temperaturlineariseret måling med Pt100...Pt1000, Ni100...Ni1000 eller termoelementføler.
- Omsætning af lineær modstandsændring til standard analogt strømsignal, f.eks. fra ventiler eller ohmske niveaustave.
- Forstærkning af bipolært mV-signal til et standard 4...20 mA strømsignal.

Teknisk karakteristik

- PR5331 kan af brugeren i løbet af få sekunder programmeres til at måle inden for alle normerede temperaturområder.
- RTD og modstandsindgangen har kabelkompensering for 2-, 3- og 4-leder tilslutning.
- Der er løbende sikkerhedscheck af gemte data.

Montage / installation

- Kan monteres i DIN form B følerhoved. I ikke-eksplosionsfarlige områder kan 5331 monteres på en DIN-skinne med PR-beslag type 8421.
- **NB:** Som Ex-barriere for 5331D anbefaler vi 5104B, 5114B eller 5116B.

APPLIKATIONER

RTD til 4...20 mA

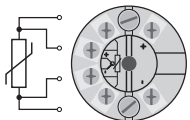

2-trådsinstallation
i kontrolrum



TC til 4...20 mA

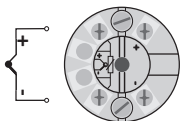

2-trådsinstallation
i kontrolrum

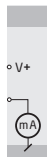

Modstand til 4...20 mA

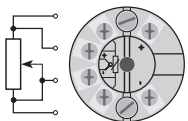

2-trådsinstallation
i kontrolrum

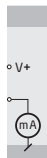

mV til 4...20 mA

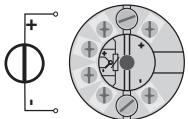

2-trådsinstallation
i kontrolrum

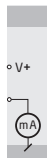

Bestillingsskema: 5331

Type	Version	Omgivelses-temperatur	Galvanisk isolation
5331	Standard : A CSA, FM, ATEX, IECEX & INMETRO : D	-40°C...+85°C : 3	1500 VAC : B

Elektriske specifikationer

Specifikationsområde:

-40°C til +85°C

Fælles specifikationer:

Forsyningsspænding DC

Standard..... 7,2...35 V

CSA, FM, ATEX, IECEX & INMETRO..... 7,2...30 VDC

Egetforbrug..... 25 mW...0,8 W

Spændingsdrop..... 7,2 VDC

Isolationsspænding, test / drift..... 1,5 kVAC / 50 VAC

Opvarmningstid..... 5 min.

Kommunikationsinterface..... Loop Link

Signal- / støjforhold..... Min. 60 dB

Reaktionstid (programmerbar)..... 1...60 s

EEPROM fejlcheck..... < 3,5 s

Signaldynamik, indgang..... 20 bit

Signaldynamik, udgang..... 16 bit

Kalibreringstemperatur..... 20...28°C

Nøjagtighed, størst af generelle og basisværdier:

Generelle værdier		
Indgangstype	Absolut nøjagtighed	Temperaturkoefficient
Alle	$\leq \pm 0,05\%$ af span	$\leq \pm 0,01\%$ af span / °C

Basisværdier		
Indgangstype	Basis-nøjagtighed	Temperaturkoefficient
RTD	$\leq \pm 0,2^\circ\text{C}$	$\leq \pm 0,01^\circ\text{C}/^\circ\text{C}$
Lin. R	$\leq \pm 0,1 \Omega$	$\leq \pm 10 \text{ m}\Omega / ^\circ\text{C}$
Volt	$\leq \pm 10 \mu\text{V}$	$\leq \pm 1 \mu\text{V} / ^\circ\text{C}$
TC-type: E, J, K, L, N, T, U	$\leq \pm 1^\circ\text{C}$	$\leq \pm 0,05^\circ\text{C} / ^\circ\text{C}$
TC-type: B, R, S, W3, W5, LR	$\leq \pm 2^\circ\text{C}$	$\leq \pm 0,2^\circ\text{C} / ^\circ\text{C}$

EMC-immunitetspårvirkning.....	$< \pm 0,5\%$ af span
Udvidet EMC-immunitet: NAMUR NE 21, A-kriterium, gniststøj.....	$< \pm 1\%$ af span

Virkning af forsyningsspændings-

ændring	$< 0,005\%$ af span / VDC
Vibration	IEC 60068-2-6 Test FC
2...25 Hz.....	$\pm 1,6 \text{ mm}$
25...100 Hz.....	$\pm 4 \text{ g}$
Max. ledningskvadrat	1 x 1,5 mm ² flerkoret ledning
Klemskruetilspændingsmoment.....	0,4 Nm
Luftfugtighed.....	$< 95\%$ RH (ikke kond.)
Mål	$\varnothing 44 \times 20,2 \text{ mm}$
Kapslingsklasse (hus / klemme)	IP68 / IP00
Vægt	50 g

Elektriske specifikationer indgang:

RTD- og lineær modstandsindgang:

RTD-type	Min. værdi	Max. værdi	Min. span	Standard
Pt100	-200°C	+850°C	25°C	IEC 60751
Ni100	-60°C	+250°C	25°C	DIN 43760
Lin. R	0 Ω	5000 Ω	30 Ω	-----

Max. nulpunktsforskydning (offset).....	50% af valgt max. værdi
Kabelmodstand pr. leder (max.).....	5 Ω
Følerstrøm.....	Nom. 0,2 mA
Virkning af følerkabelmodstand (3- / 4-leder)	$< 0,002 \Omega/\Omega$
Følerfejlsdetektering.....	Ja

TC-indgang:

Type	Min. temperatur	Max. temperatur	Min. span	Standard
B	+400°C	+1820°C	100°C	IEC584
E	-100°C	+1000°C	50°C	IEC584
J	-100°C	+1200°C	50°C	IEC584
K	-180°C	+1372°C	50°C	IEC584
L	-100°C	+900°C	50°C	DIN 43710
N	-180°C	+1300°C	50°C	IEC584
R	-50°C	+1760°C	100°C	IEC584
S	-50°C	+1760°C	100°C	IEC584
T	-200°C	+400°C	50°C	IEC584
U	-200°C	+600°C	50°C	DIN 43710
W3	0°C	+2300°C	100°C	ASTM E988-90
W5	0°C	+2300°C	100°C	ASTM E988-90
LR	-200°C	+800°C	50°C	GOST 3044-84

Max. nulpunktsforskydning (offset)..... 50% af valgt max. værdi

Koldt loddestedskomp. (CJC)..... < ±1,0°C

Følerfejlsdetektering..... Ja

Følerfejlsstrøm:

under detektering..... Nom. 33 µA

ellers..... 0 µA

Spændingsindgang:

Måleområde -12...800 mV

Min. måleområde (span)..... 5 mV

Max. nulpunktsforskydning (offset)..... 50% af valgt max. værdi

Indgangsmodstand 10 MΩ

Udgang:**Strømudgang:**

Signalområde..... 4...20 mA

Min. signalområde..... 16 mA

Opdateringstid 440 ms

Udgangssignal ved EEpromfejl..... ≤ 3,5 mA

Belastningsmodstand ≤ (V_{forsyn.} - 7,2) / 0,023 [Ω]

Belastningsstabilitet < ±0,01% af span / 100 Ω

Følerfejlsdetektering:

Programmerbar 3,5...23 mA

NAMUR NE43 Upscale..... 23 mA

NAMUR NE43 Downscale..... 3,5 mA

Af span = Af det aktuelt valgte område

Godkendelser:

EMC 2004/108/EF EN 61326-1

GOST R

Marinegodkendelse:

Det Norske Veritas, Ships & Offshore Stand. f. Certific. No. 2.4

Ex / I.S.:

ATEX 94/9/EF

5331A KEMA 10ATEX0002 X

5331D KEMA 06ATEX0062 X

FM-certifikat 2D5A7

CSA-certifikat 1125003

IECEX DEK 13.0035X

INMETRO DEKRA 13.0001 X

GOST Ex

TILSLUTNINGER

Indgang:

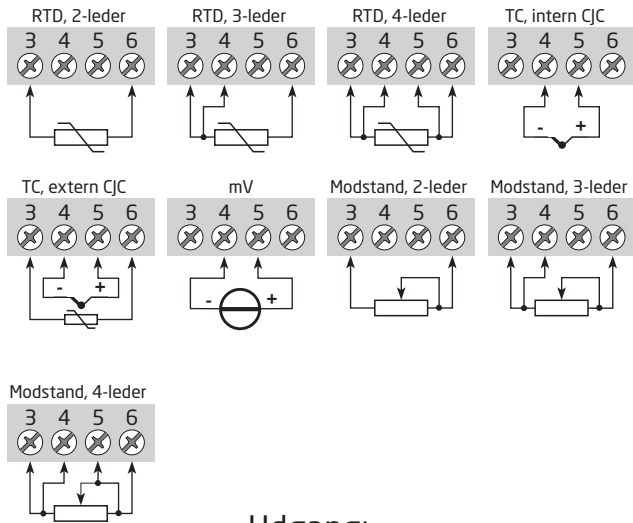

Udgang:

2-Trådsinstallation

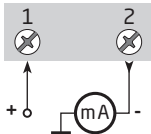

BLOKDIAGRAM

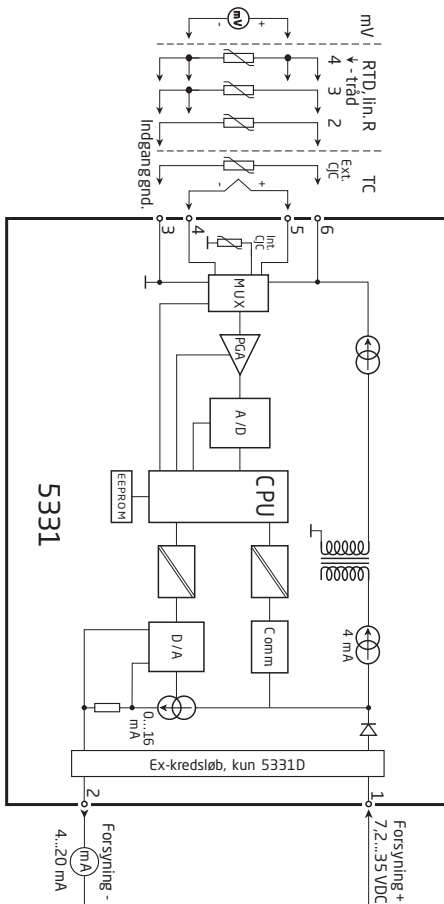

Mekaniske specifikationer

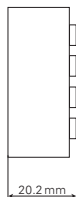
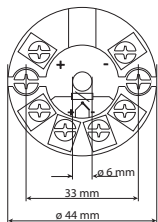

Montering af følerledninger

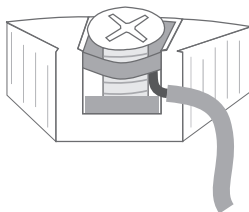

Ledninger monteres mellem metalpladerne

APPENDIX

ATEX Installation Drawing - 5331A

ATEX Installation Drawing - 5331D

IECEX installation drawing - 5331A

IECEX installation drawing - 5331D

FM Installation Drawing - 5331D

CSA Installation Drawing - 5331D

INMETRO Instruções de Segurança - 5331A

INMETRO Instruções de Segurança - 5331D

ATEX Installationstegning

For sikker installation af 5331A3B eller 5334A3B skal følgende overholdes: Modulet må kun installeres af kvalificerede personer, som er bekendt med national og international lovgivning, direktiver og standarder i det land, hvor modulet skal installeres.

Produktionsår fremgår af de to første cifre i serienummeret.

ATEX-certifikat KEMA 10ATEX 0002 X

Mærkning  II 3 G Ex nA [ic] IIC T4 ... T6 Gc
II 3 G Ex ic IIC T4...T6 Gc
II 3 D Ex ic IIC Dc

Standarder EN 60079-0 : 2012, EN 60079-11 : 2012, EN 60079-15 : 2010

T4: $-40 \leq T_a \leq 85^{\circ}\text{C}$ T6: $-40 \leq T_a \leq 60^{\circ}\text{C}$	Klemme: 3,4,5,6 Ex nA [ic] Uo: 9,6 V Io: 25 mA Po: 60 mW Lo: 33 mH Co: 2,4 μF	Klemme: 1,2 Ex nA Umax. \leq 35 VDC	Klemme: 1,2 Ex ic Ui = 35 VDC Ii = 110 mA Li = 10 μH Ci = 1,0 nF
--	---	--	---

Særlige betingelser for sikker anvendelse:

For beskyttelsestype Ex nA skal transmitteren monteres i et hus med en tæthedegrad på mindst IP54 i overensstemmelse med EN 60529.

Ved installationer i områder med potentiel eksplosionsfare på grund af brændbart støv, skal transmitteren monteres i et hus med en tæthedegrad på mindst IP6X i overensstemmelse med EN 60529. Husets overfladetemperatur er 20 K over omgivelsestemperaturen.

Hvis omgivelsestemperaturen $\geq 60^{\circ}\text{C}$, skal der bruges varmebestandige kabler med specifikationer på mindst 20K over omgivelsestemperaturen.

ATEX Installationstegning



For sikker installation af 5331D eller 5334B skal følgende overholdes: Modulet må kun installeres af kvalificerede personer, som er bekendt med national og international lovgivning, direktiver og standarder i det land, hvor modulet skal installeres.

Produktionsår fremgår af de to første cifre i serienummeret.

ATEX-certifikat KEMA 06ATEX 0062 X

Mærkning  II 1 G Ex ia IIC T4...T6 Ga
II 1 D Ex ia IIIC Da
II 1 M Ex ia I Ma

Standarder EN 60079-0 : 2012, EN 60079-11 : 2012, EN 60079-26 : 2007,
EN 60079-15 :2010

Ex-område
Zone 0, 1, 2, 20, 21, 22

T4: $-40 \leq T_a \leq 85^\circ\text{C}$
T6: $-40 \leq T_a \leq 60^\circ\text{C}$

Klemme: 3,4,5,6

Uo: 9,6 VDC
Io: 25 mA
Po: 60 mW
Lo: 33 mH
Co: 2,4µF



Klemme: 1,2

Ui: 30 VDC
Ii: 120 mA
Pi: 0,84 W
Li: 10µH
Ci: 1,0nF

Ikke Ex-område

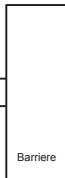

Installationsforskrifter

Følerkredsløbet er ikke ufejlbarligt galvanisk isoleret fra indgangskredsløbet, men den galvaniske isolation mellem kredsene kan modstå en testspænding på 500 VAC i 1 minut.

I områder med potential eksplosionsfare på grund af brændbar gas skal transmitteren installeres i et hus med en kapslingsklasse på mindst IP20 i overensstemmelse med EN60529.

Hvis transmitteren installeres i eksplosive atmosfærer, hvor kategori 1 G, 1 M eller 2 M udstyr er krævet, og hvis huset er lavet af aluminium, skal det installeres således, at der selv ved sjældent opstående hændelser ikke er risiko for antændelse på grund af stød og friktionsgnister; hvis huset er lavet af ikke-metallisk materiale, skal elektrostatiske ladninger på transmitters hus undgås.

For installation i områder med potentiel eksplosionsfare på grund af brændbart støv skal følgende overholdes:

Transmitteren skal monteres i et form B metalhus i overensstemmelse med DIN 43729. Huset skal have en tæthedsgard på mindst IP 6X i overensstemmelse med EN 60529 og skal være egnet til den pågældende applikation samt være installeret korrekt.

Der må kun anvendes kabelforskrutninger og blindstik, som egner sig til den pågældende applikation og som installeres korrekt.

Hvis omgivelsestemperaturen $\geq 60^{\circ}\text{C}$, skal der bruges varmebestandige kabler med specifikationer på mindst 20K over omgivelsestemperaturen.

Husets overfladetemperatur er lig med den maksimale omgivelsestemperatur plus 20 K for støvlæg med en tykkelse på op til 5 mm.

IECEx Installation drawing



For safe installation of 5331A or 5334A the following must be observed. The module shall only be installed by qualified personnel who are familiar with the national and international laws, directives and standards that apply to this area.
Year of manufacture can be taken from the first two digits in the serial number.

Certificate	IECEx DEK 13.0035X
Marking	Ex nA [ic] IIC T4..T6 Gc Ex ic IIC T4..T6 Gc Ex ic IIIC Dc
Standards	IEC 60079-0 : 2011, IEC 60079-11 : 2011, IEC 60079-15 : 2010

T4: $-40 \leq T_a \leq 85^\circ\text{C}$	Terminal: 3,4,5,6	Terminal: 1,2	Terminal: 1,2
T6: $-40 \leq T_a \leq 60^\circ\text{C}$	Uo: 9.6 V	Ex nA	Ex ic
	Io: 25 mA		
	Po: 60 mW	Umax =35 VDC	Ui = 35 VDC
	Lo: 33 mH		Ii = 110mA
	Co: 2.4 μF		Li = 10 μH
			Ci = 1.0 nF

Installation note:

For installation in a potentially explosive gas atmosphere, the following instructions apply:
For nA installation the transmitter must be installed in a metal enclosure, e.g. a form B enclosure providing a degree of protection of at least IP54 according to IEC60529 or in an enclosure with type of protection Ex n or Ex e.

For ic installation the transmitter must be installed in enclosure providing a degree of protection of at least IP20 according to IEC60529 and that is suitable for the application.

Cable entry devices and blanking elements shall fulfill the same requirements
For an ambient temperature $\geq 60^\circ\text{C}$, heat resistant cables shall be used with a rating of at least 20 K above the ambient temperature.

For installation in a potentially explosive dust atmosphere, the following instructions apply:
The surface temperature of the enclosure is equal to the ambient temperature plus 20 K, for a dust layer with a thickness up to 5 mm.
The transmitter must be mounted in a enclosure according to DIN 43729 that provides a degree of protection of at least IP6X according to IEC60529, and that is suitable for the application. Cable entry devices and blanking elements shall fulfill the same requirements.

IECEx Installation drawing



For safe installation of 5331D or 5334B the following must be observed. The module shall only be installed by qualified personnel who are familiar with the national and international laws, directives and standards that apply to this area.

Year of manufacture can be taken from the first two digits in the serial number.

Certificate	IECEx DEK 13.0035X
Marking	Ex ia IIC T4...T6 Ga Ex ia IIIC Da Ex ia I Ma
Standards	IEC 60079-0 : 2011, IEC 60079-11 : 2011, IEC 60079-26:2006

Hazardous area

Zone 0, 1, 2, 20, 21, 22, M1

T4: $-40 \leq T_a \leq 85^\circ\text{C}$

T5: $-40 \leq T_a \leq 60^\circ\text{C}$

T6: $-40 \leq T_a \leq 45^\circ\text{C}$

Terminal: 3,4,5,6

Uo: 9.6 VDC

Io: 25 mA

Po: 60 mW

Lo: 33 mH

Co: 2.4 μF

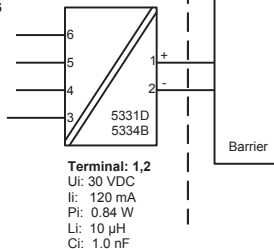

Installation notes.

The sensor circuit is not infallibly galvanic isolated from the input circuit. However, the galvanic isolation between the circuits is capable of withstanding a test voltage of 500Vac during 1 minute.

In a potentially explosive gas atmosphere, the transmitter shall be mounted in a metal form B enclosure in order to provide a degree of protection of at least IP20 according to IEC60529. If however the environment requires a higher degree of protection, this shall be taken into account.

If the transmitter is installed in an explosive atmosphere requiring the use of equipment protection level Ga, Ma and Mb, and if the enclosure is made of aluminum, it must be installed such, that ignition sources due to impact and friction sparks are excluded.

For installation in a potentially explosive dust atmosphere, the following instructions apply:

For explosive dust atmospheres, the surface temperature of the outer enclosure is 20 K above the ambient temperature.

The transmitter shall be mounted in a metal enclosure form B according to DIN43729 that is providing a degree of protection of at least IP6X according to IEC60529, that is suitable for the application and correctly installed.

Cable entries and blanking elements shall be used that are suitable for the application and correctly installed.

For an ambient temperature $\geq 60^{\circ}\text{C}$, heat resistant cables shall be used with a rating of at least 20 K above the ambient temperature.

FM Installation Drawing 5300Q502 Rev AH

Model 5331C, 5331D, 5333C, 5333D and 5343B

Hazardous (Classified) Location

Class I, Division 1, Groups, A, B, C, D
Class I, Zone 0, IIC

Ambient temperature limits
T4: -40 to +85 deg. Celsius
T6: -40 to +60 deg. Celsius

Terminal 1, 2
V_{max} or U_i: 30 V
I_{max} or I_i: 120 mA
P_{max} or P_i: 0.84 W
C_i: 1 nF
L_i: 10 uH

Terminal 3, 4, 5, 6
Only passive, or non-energy storing devices such as RTD's and Thermocouples may be connected.

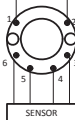

Non Hazardous Location

Associated Apparatus
or Barrier
with
entity Parameters:

UM ≤ 250V
V_{oc} or U_o ≤ V_{max} or U_i
I_{sc} or I_o ≤ I_{max} or I_i
P_o ≤ P_i
C_a or C_o ≥ C_i + C_{cable}
L_a or L_o ≥ L_i + L_{cable}

This device must not be connected to any associated apparatus which uses or generates more than 250 VRMS

Model 5335C, 5335D, 5336D, 5337D

Hazardous (Classified) Location

Class I, Division 1, Groups, A, B, C, D
Class I, Zone 0, IIC

Ambient temperature limits
T4: -40 to +85 deg. Celsius
T6: -40 to +60 deg. Celsius

Terminal 1, 2
V_{max} or U_i: 30 V
I_{max} or I_i: 120 mA
P_{max} or P_i: 0.84 W
C_i: 1 nF
L_i: 10 uH

Terminal 3, 4, 5, 6
V_i or U_o: 9.8 V
I_i or I_o: 28 mA
P_i or P_o: 67.2 mW
C_a or C_o: 3.5 uF
L_a or L_o: 35 mH

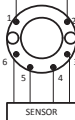

Non Hazardous Location

Associated Apparatus
or Barrier
with
entity Parameters:

UM ≤ 250V
V_{oc} or U_o ≤ V_{max} or U_i
I_{sc} or I_o ≤ I_{max} or I_i
P_o ≤ P_i
C_a or C_o ≥ C_i + C_{cable}
L_a or L_o ≥ L_i + L_{cable}

This device must not be connected to any associated apparatus which uses or generates more than 250 VRMS

The entity concept

The Transmitter must be installed according to National Electrical Code (ANSI-NFPA 70) and shall be installed with the enclosure, mounting, and spacing segregation requirement of the ultimate application.

Equipment that is FM-approved for intrinsic safety may be connected to barriers based on the ENTITY CONCEPT. This concept permits interconnection of approved transmitters, meters and other devices in combinations which have not been specifically examined by FM, provided that the agency's criteria are met. The combination is then intrinsically safe, if the entity concept is acceptable to the authority having jurisdiction over the installation.

The entity concept criteria are as follows:

The intrinsically safe devices, other than barriers, must not be a source of power.

The maximum voltage $U_i(V_{MAX})$ and current $I_i(I_{MAX})$, and maximum power $P_i(P_{MAX})$, which the device can receive and remain intrinsically safe, must be equal to or greater than the voltage (U_o or V_{OC} or V_t) and current (I_o or I_{SC} or I_t) and the power P_o which can be delivered by the barrier.

The sum of the maximum unprotected capacitance (C_i) for each intrinsically device and the interconnecting wiring must be less than the capacitance (C_a) which can be safely connected to the barrier.

The sum of the maximum unprotected inductance (L_i) for each intrinsically device and the interconnecting wiring must be less than the inductance (L_a) which can be safely connected to the barrier.

The entity parameters U_o, V_{OC} or V_t and I_o, I_{SC} or I_t , and C_a and L_a for barriers are provided by the barrier manufacturer.

NI Field Circuit Parameters

Model 5331C, 5331D, 5333C, 5333D, 5335C, 5335D, 5336D, 5337D and 5343B

Hazardous (Classified) Location

Class I, Division 2, Groups, A, B, C, D
Class I, Zone 2, IIC

Ambient temperature limits
T4: -40 to +85 deg. Celcius
T6: -40 to +60 deg. Celcius

Terminal 1, 2
 V_{max} : 35 V
 C_i : 0 μ F
 L_i : 10 μ H

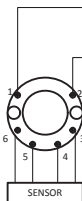

Non Hazardous Location

Associated Apparatus
or Barrier

This device must not be connected to any associated apparatus which uses or generates more than 250 VRMS

CSA Installation drawing 533XQC03

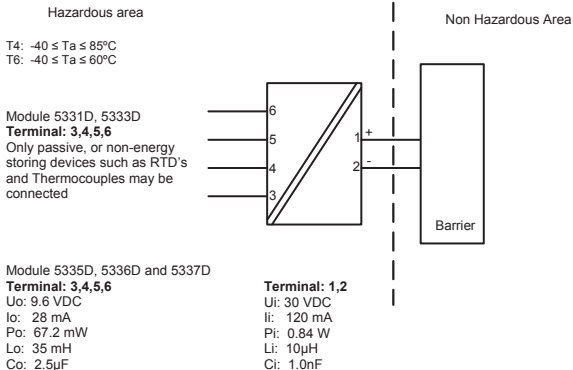

CLASS 2258 04 - PROCESS CONTROL EQUIPMENT - Intrinsically Safe Entity - For Hazardous Locations

Class I, Division 1, Groups A, B, C and D
Ex ia IIC, Ga

CLASS 2258 84 - PROCESS CONTROL EQUIPMENT - Intrinsically Safe Entity - For Hazardous Locations - Certified to US Standards

Class I, Division 1, Groups A, B, C and D
Class I, Zone 0, AEx ia IIC, Ga

Warning:

Substitution of components may impair intrinsic safety.

The transmitters must be installed in a suitable enclosure to meet installation codes stipulated in the Canadian Electrical Code (CEC) or for US the National Electrical Code (NEC).

Desenho de Instalação INMETRO



Para instalação segura do 5331A ou 5334A o seguinte deve ser observado. O modo deve apenas ser instalado por pessoas qualificadas que são familiarizadas com as leis nacionais e internacionais, diretrizes e padrões que se aplicam a esta área.

Ano de fabricação pode ser pego dos dois primeiros dígitos do número de série.

Certificado	DEKRA 13.0001 X
Indicação	Ex nA [ic] IIC T4..T6 Gc Ex ic IIC T4..T6 Gc Ex ic IIIC Dc

Padrões ABNT NBR IEC 60079-0 : 2008, ABNT NBR IEC 60079-11 : 2009,
IEC 60079-15 : 2010, ABNT NBR IEC 60079-26 : 2008

T4: $-40 \leq T_a \leq 85^{\circ}\text{C}$ T6: $-40 \leq T_a \leq 60^{\circ}\text{C}$	Terminal: 3,4,5,6 Uo: 9,6 V Io: 25 mA Po: 60 mW Lo: 33 mH Co: 2,4 μF	Terminal: 1,2 Ex nA Umax =35 VDC	Terminal: 1,2 Ex ic Ui = 35 VDC Ii = 110 mA Li = 10 μH Ci = 1,0 nF
--	---	---	---

Notas para instalação

Para a instalação em uma atmosfera de gás potencialmente explosivo, se aplicam as instruções a seguir:

Para a instalação nA o transmissor deve ser instalado em um gabinete de metal, por exemplo, gabinete em forma B que forneça um grau de proteção de pelo menos IP54 de acordo com IEC60529 ou em um caixa com tipo de proteção Ex n ou Ex e.

Para a instalação IC o transmissor deve ser instalado em um invólucro proporcionando um grau de proteção de IP20, pelo menos, de acordo com a norma IEC60529 que é adequado para a aplicação.

Dispositivos de entrada de cabos e elementos de supressão devem cumprir os mesmos requisitos.

Para uma temperatura ambiente $\geq 60^{\circ}\text{C}$, os cabos resistentes ao calor precisam ser utilizados com uma classificação de pelo menos 20 K acima da temperatura ambiente.

Para a instalação em uma atmosfera de poeira potencialmente explosiva, se aplicam as instruções a seguir:

A temperatura da superfície do invólucro é igual à temperatura ambiente mais 20 K, para uma camada de pó, com uma espessura superior a 5 mm.

O transmissor deve ser montado em um invólucro de acordo com a norma DIN 43729, que proporciona um grau de proteção de, pelo menos, IP6X de acordo com a norma IEC60529, e que seja apropriado para a aplicação.

Dispositivos de entrada de cabos e elementos de supressão devem cumprir as mesmas exigências.

Desenho de Instalação INMETRO



Para instalação segura do 5331D ou 5334B o seguinte deve ser observado. O modo deve apenas ser instalado por pessoas qualificadas que são familiarizadas com as leis nacionais e internacionais, diretrizes e padrões que se aplicam a esta área.
Ano de fabricação pode ser pego dos dois primeiros dígitos do número de série.

CertificadoDEKRA 13.0001 X

Indicação Ex ia IIC T6...T4 Ga
Ex ia IIIC Da

Padrões ABNT NBR IEC 60079-0 : 2008 ABNT NBR IEC 60079-11 : 2009 IEC 60079-15 : 2010
ABNT NBR IEC 60079-26 : 2008

Áreas Perigosas

Zona 0, 1, 2, 20, 21, 22,

T4: $-40 \leq T_a \leq 85^\circ\text{C}$

T5: $-40 \leq T_a \leq 60^\circ\text{C}$

T6: $-40 \leq T_a \leq 45^\circ\text{C}$

Terminal: 3,4,5,6

Uo: 9,6 VDC

Io: 25 mA

Po: 60 mW

Lo: 33 mH

Co: 2,4 μF

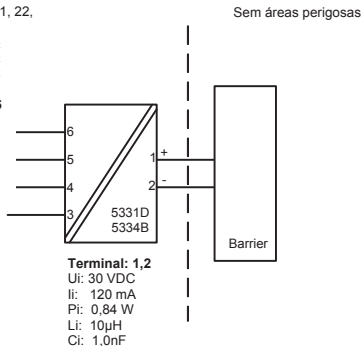

Notas de instalação

O circuito do sensor não é isolado galvanicamente infalível do circuito de entrada. Contudo, a isolação galvânica entre os circuitos é capaz de resistir a um teste de tensão de 500Vac durante 1 minuto.

Em uma atmosfera de gás potencialmente explosiva, o transmissor deve ser montado em um enclosure a fim de garantir um grau de proteção de no mínimo IP20 de acordo com EN60529. Se contudo o ambiente requer um nível de proteção maior, isso deve ser levado em conta

Se o transmissor é instalado em uma atmosfera explosiva exigindo o uso de equipamento de categoria Ga e se o enclosure é feito de alumínio, ele deve ser instalado de modo que, mesmo em caso de avaria rara, fontes de ignição devido a impacto e fricção, faíscas são eliminadas; se o enclosure é feito de materiais não metálicos, cargas eletroestáticas devem ser evitadas.

Para instalação em atmosfera de poeira potencialmente explosiva, as instruções a seguir:

O transmissor deve ser montado em enclosure de metal forma B de acordo com DIN43729 que está fornecendo um grau de proteção de pelo menos IP6X de acordo com EN60529. Isso é adequado para aplicação e corretamente instalado.

As entradas dos cabos e os elementos de obturação que podem ser utilizados são adequados para a aplicação e corretamente instalados.

Para temperatura ambiente $\geq 60^{\circ}\text{C}$, fios de resistência ao calor devem ser usados com uma faixa de pelo menos 20K acima da temperatura ambiente.

A temperatura da superfície do enclosure é igual à temperatura ambiente mais de 20 K, por uma camada de pó, com uma espessura até 5 mm.



Displays Programmable displays with a wide selection of inputs and outputs for display of temperature, volume and weight, etc. Feature linearisation, scaling, and difference measurement functions for programming via PReset software.



Ex interfaces Interfaces for analogue and digital signals as well as HART® signals between sensors / I/P converters / frequency signals and control systems in Ex zone 0, 1 & 2 and for some devices in zone 20, 21 & 22.



Isolation Galvanic isolators for analogue and digital signals as well as HART® signals. A wide product range with both loop-powered and universal isolators featuring linearisation, inversion, and scaling of output signals.



Temperature A wide selection of transmitters for DIN form B mounting and DIN rail devices with analogue and digital bus communication ranging from application-specific to universal transmitters.



Universal PC or front programmable devices with universal options for input, output and supply. This range offers a number of advanced features such as process calibration, linearisation and auto-diagnosis.



  www.preelectronics.fr
 sales@preelectronics.fr

  www.preelectronics.de
 sales@preelectronics.de

  www.preelectronics.es
 sales@preelectronics.es

  www.preelectronics.it
 sales@preelectronics.it

  www.preelectronics.se
 sales@preelectronics.se

  www.preelectronics.com
 sales@preelectronics.com

  www.preelectronics.com
 sales@preelectronics.com

  www.preelectronics.cn
 sales@preelectronics.cn

Head office

Denmark
PR electronics A/S
Lerbakken 10
DK-8410 Rønede

www.preelectronics.com
sales@preelectronics.dk
tel. +45 86 37 26 77
fax +45 86 37 30 85



QUALITY SYSTEM AND ENVIRONMENTAL MANAGEMENT SYSTEM
DS/EN ISO 9001
DS/EN ISO 14001

